

ISFD® TECHNOLOGY

Integral Squeeze Film Damper Solution to Control Vibrations

ISFD technology from Bearings Plus® provides highly engineered damping and stiffness to shift critical speeds and increase the dynamic stability of the rotor/bearing system.

The patented design, manufactured through electrical discharge machining (EDM), integrates the damper and bearing for a space-saving solution suitable for both new and retrofit applications.

OPTIMIZE DAMPING AND STIFFNESS

The hallmark of the ISFD design is the independence of the damping and stiffness, each optimized for the application through rotordynamic analysis.

Damping is precisely controlled by isolated damper films that absorb energy through the piston/dashpot effect. The “S” shape springs that segment the damper land define the stiffness and offer accurate predictability.

This design (Figure 1) provides higher and more accurate damping capability than a conventional squeeze film damper.

CENTER UNDER STATIC LOAD

The ISFD design also centers the rotor under static load. It overcomes the deficiencies of O-ring dampers by providing centering without sag, linear stiffness unaffected by temperature or age, and acceptance of high radial loads.

IMPROVE STABILITY

By introducing flexibility into the rotor/bearing system and providing optimum damping, ISFD technology maximizes the energy dissipation at the bearing locations and significantly improves the stability of the system (Figure 2 on back).

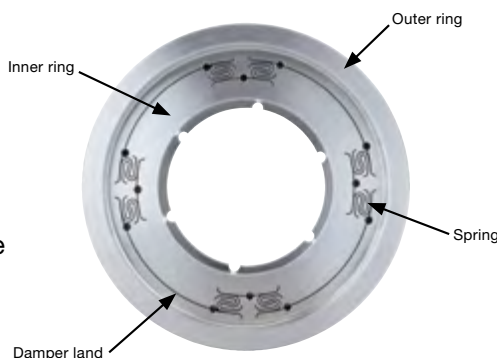

Figure 1: ISFD design

AT A GLANCE

Unique Damper Design

- Precise stiffness and damping
- Drop-in replacement without modification to the housing
- Shaft-centering ability
- Split configuration availability
- Constant stiffness and damping over a wide range of motion
- No cavitation

Versatility

ISFD technology allows flexibility in rotor/bearing configurations and can be used with:

- Flexure Pivot® bearings
- Tilt pad bearings
- Fixed profile bearings
- Rolling element bearings

Stability Issue Without ISFD Technology

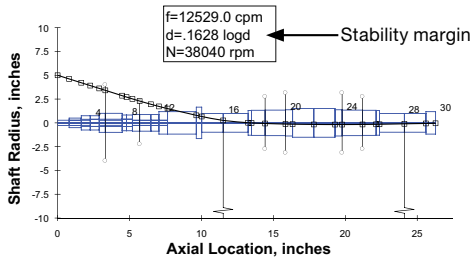

Figure 2

SHIFT CRITICAL SPEEDS AND REDUCE AMPLIFICATION FACTOR

ISFD technology can shift critical speeds and significantly reduce the amplification factor (Figure 3). With the reduction in amplification factor, machine seal clearances can be tightened to reduce gas or steam leakage (Figure 4).

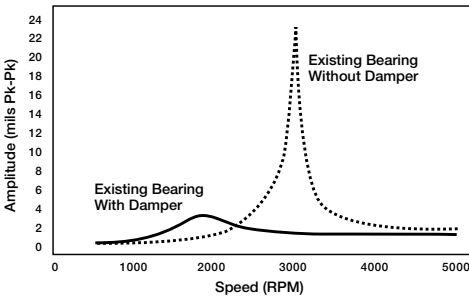

Figure 3

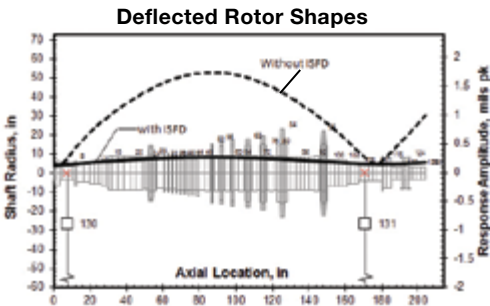
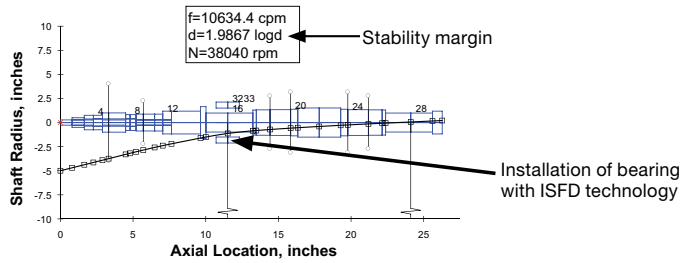

Figure 4

Stability Improvement With ISFD Technology



REDUCE DYNAMIC BEARING (TRANSMITTING) FORCES

ISFD technology reduces the dynamic load that is transmitted to the bearings (Figure 5), which reduces pedestal vibration and increases bearing life, particularly for rolling element bearings. For fluid film bearings, the technology can mitigate pivot wear and reduce babbitt fatigue.

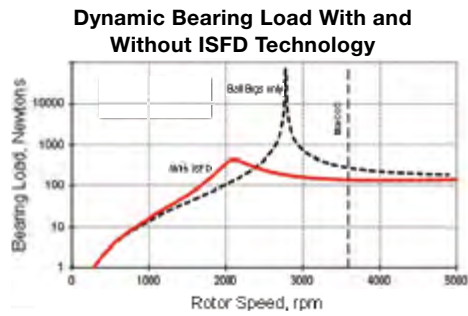

Figure 5

DECREASE UNBALANCE SENSITIVITY

ISFD technology helps reduce the sensitivity to unbalance (Figure 6), protecting impellers and seals from rubbing and increasing maintenance intervals.

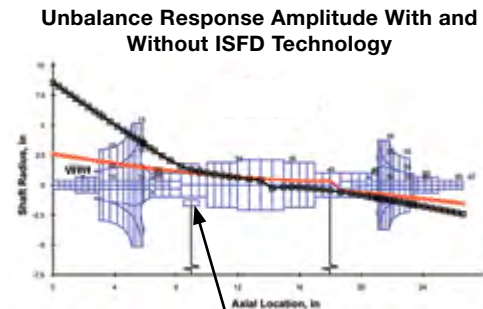

Figure 6

Installation of bearing with ISFD technology